

PLUS

Design: Piet Billekens

Negli oggetti di uso quotidiano la ricerca del segno formale rende talvolta secondaria la funzionalità. Piet Billekens ha ristabilito nel progetto PLUS l'equilibrio tra concetto e funzione, disegnando complementi d'arredo non subordinati a stili o tendenze. Massima attenzione ai materiali e peculiare controllo dei processi di lavorazione sono garantiti dalle Aziende produttrici che condividono il concetto di qualità totale.

Sometimes the research of a formal design in everyday used objects might give to functionality a secondary role. Thanks to Arch. Piet Billekens the project PLUS, has re-established the balance between concept and function, designing furnishing complements free from any style or trend. The highest attention was also given to the materials, with a peculiar control to the manufacturing process granted by Companies sharing the common concepts of total quality.

Plus

Design: Piet Billekens



*"Senza entusiasmo non si è mai compiuto
niente di grande."*

*"Nothing great was ever achieved
without enthusiasm."*

Ralph W. Emerson

















Plus

Design: Piet Billekens



Materiale: Material:	Ottone Brass	Finitura: Finish:	<input type="radio"/> Cromo Chrome
Complemento: Complements:	<input checked="" type="radio"/> Vetro trasparente Clear glass	Attenzione: Attention:	Le misure sono espresse in centimetri Sizes are in centimetres
Attenzione: Attention:	<input checked="" type="radio"/> SI biadesivo Double sided tape YES	<input checked="" type="radio"/> NO biadesivo Double sided tape NO	

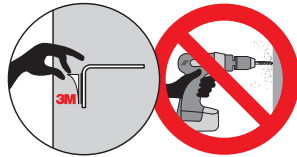

La serie Plus è fornita completa di viti, tasselli e brugole di montaggio. Esiste altresì la possibilità di utilizzare per ogni punto di fissaggio un kit con biadesivo (Art. B523M).
Disponibile a partire da Novembre 2012.
Our Plus collection is delivered complete with screws, plugs and Allen key. Wall fixing with adhesive is available. Please ask for the correct component for each fixing point (Art. B523M).
Only available as from November 2012.



W4901
Porta sapone inamovibile
Irremovable soap dish holder

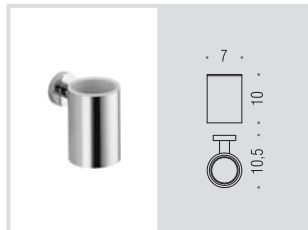

W4902
Porta bicchiere inamovibile
Irremovable glass holder

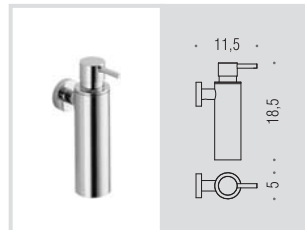

B4981
Spandisapone (L 0,15)
Soap dispenser

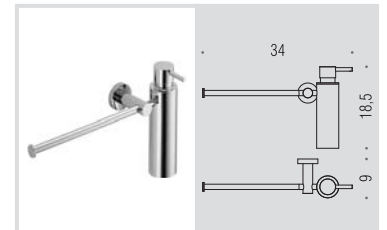

W4975
Spandisapone (L 0,15)
e porta salvietta bidet
Soap dispenser and towel holder for bidet

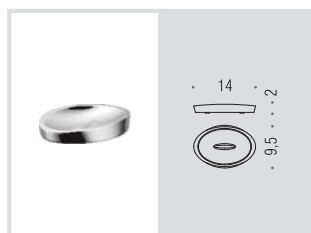

W4940
Porta sapone d'appoggio
Standing soap dish holder

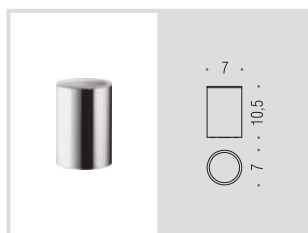

W4941
Porta bicchiere d'appoggio
Standing glass holder

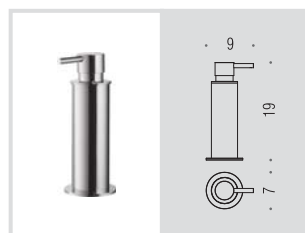

W4980
Spandisapone (L 0,15)
d'appoggio
Standing soap dispenser

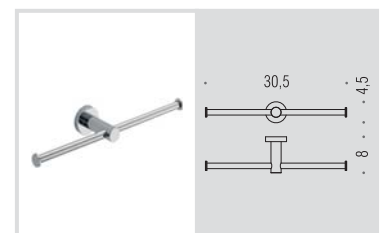

W4990
Porta rotolo doppio
Double Paper holder

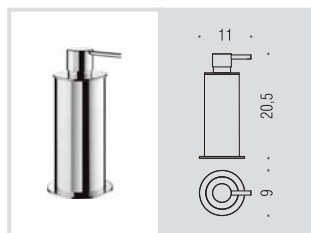

W4980 XL
Reggimensola
regolabile 6-12 mm
Adjustable shelf holder (6-12 mm)



W4917
Appenditutto
Hook

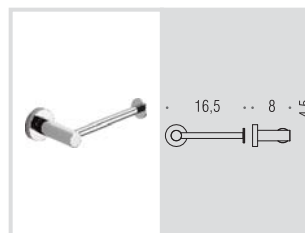

W4908
Porta rotolo reversibile
Reversible paper holder

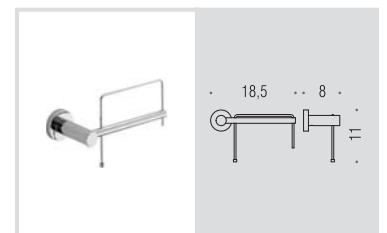

W4908 DX-SX
Porta rotolo
Paper holder

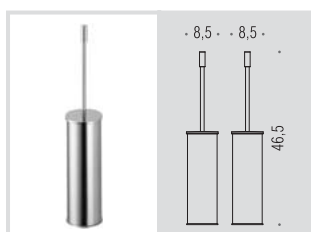

W4961
Porta scopino d'appoggio
Standing brush holder

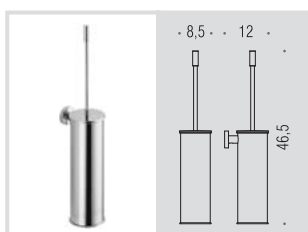

W4962
Porta scopino
Hanging brush holder

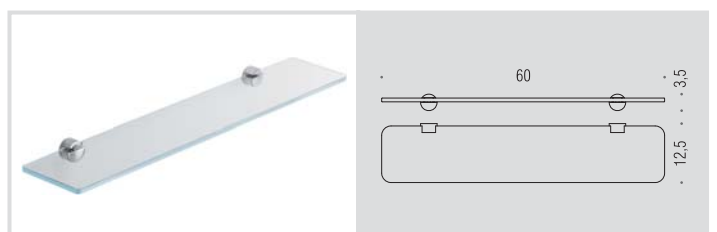

W4916
Mensola
Shelf

Plus

Design: Piet Billekens



W4909 - W4910

Porta salvietta
Towel holder

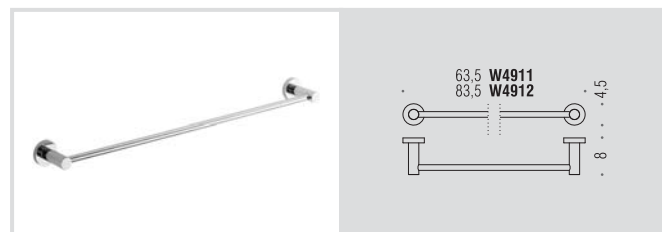

W4911 - W4912

Porta salvietta
Towel holder

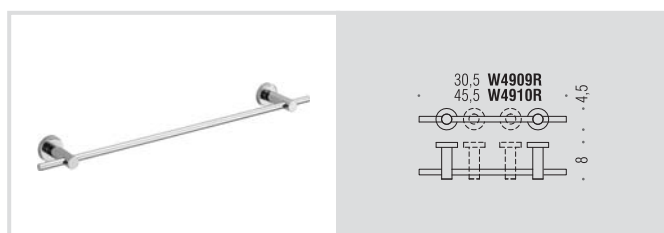

W4909R - W4910R

Porta salvietta con supporti regolabili
Towel holder, adjustable supports

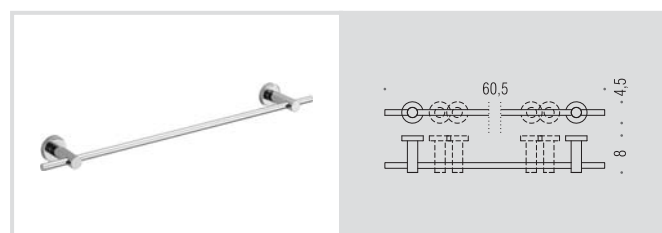

W4911R

Porta salvietta con supporti regolabili
Towel holder, adjustable supports

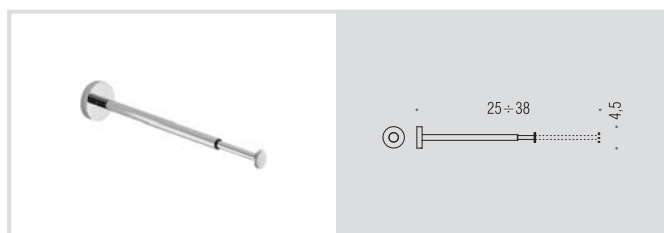

W4915

Porta salvietta estensibile
Extensible towel holder

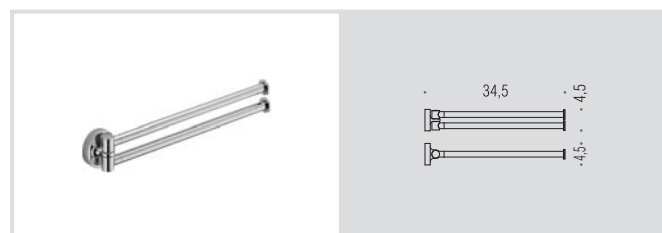

W4913

Porta salvietta doppio a snodo
Double bar towel holder

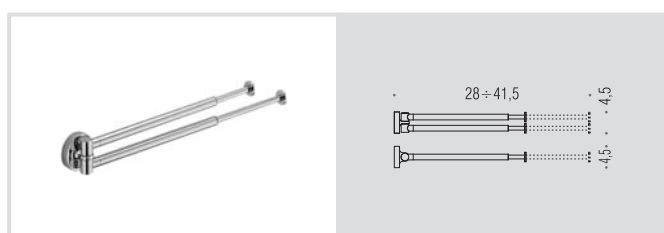

W4914

Porta salviette doppio estensibile a snodo
Extensible double bar towel holder

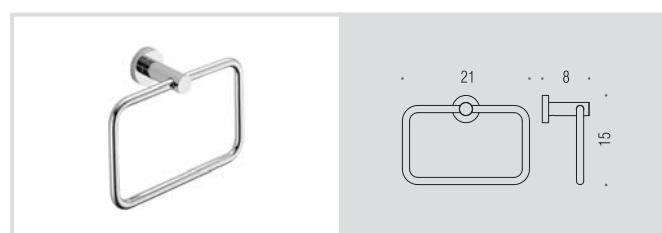

W4931

Porta salvietta ad anello
Ring towel holder



Materiale: Material:	Ottone Brass	Finitura: Finish:	<input type="radio"/> Cromo Chrome	<input type="radio"/> Verniciato bianco White lacquered	<input checked="" type="radio"/> Verniciato blue Blue lacquered
Complemento: Complements:	<input type="radio"/> Vetro trasparente Clear glass	<input checked="" type="radio"/> Metacrilato Metacrylate	<input checked="" type="radio"/> Verniciato nero Black lacquered	<input type="radio"/> Verniciato nikelmat Mat nickel lacquered	
Attenzione: Attention:	Le misure sono espresse in centimetri Sizes are in centimetres	Attenzione: Attention:	<input checked="" type="radio"/> SI biadesivo Double sided tape YES	<input checked="" type="radio"/> NO biadesivo Double sided tape NO	

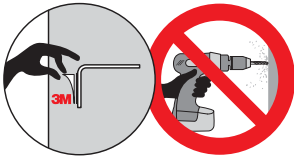

La serie Plus è fornita completa di viti, tasselli e brugole di montaggio. Esiste altresì la possibilità di utilizzare per ogni punto di fissaggio un kit con biadesivo (Art. B523M). Disponibile a partire da Novembre 2012.
Our Plus collection is delivered complete with screws, plugs and Allen key. Wall fixing with adhesive is available. Please ask for the correct component for each fixing point (Art. B523M). Only available as from November 2012.

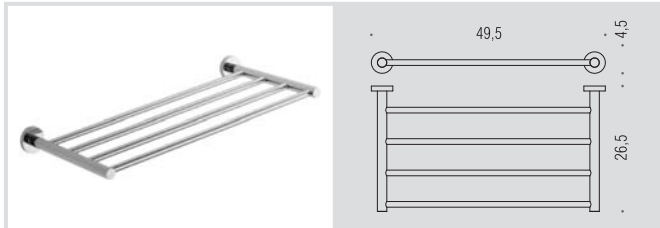

W4987
Rack porta salvietta
Rack towel holder

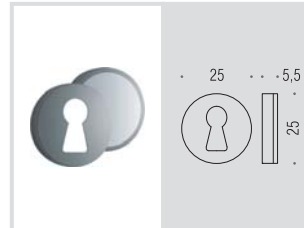

B9956
Armadietto portachiavi con specchio (8 posizioni)
Key holder locker with mirror

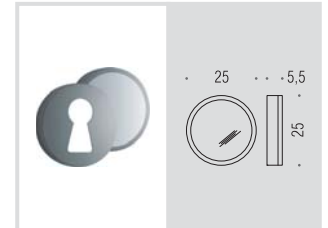

B9957
Armadietto portachiavi con specchio (8 posizioni)
Key holder locker with mirror

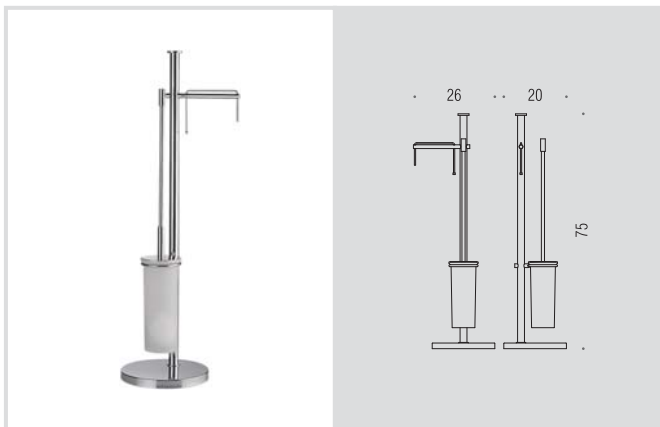

W4935
Piantana con porta rotolo e porta scopino
Standing column equipped with paper holder and brush holder



W4936
Piantana con due porta salvietta
Standing column equipped with two towel holders

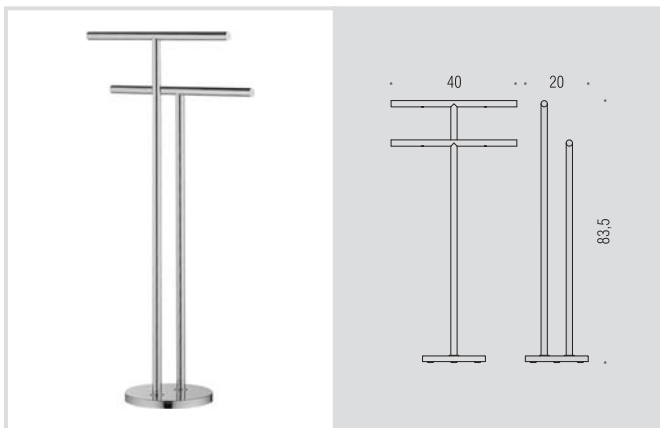

W4938
Piantana con due porta salvietta
Standing column equipped with two towel holders

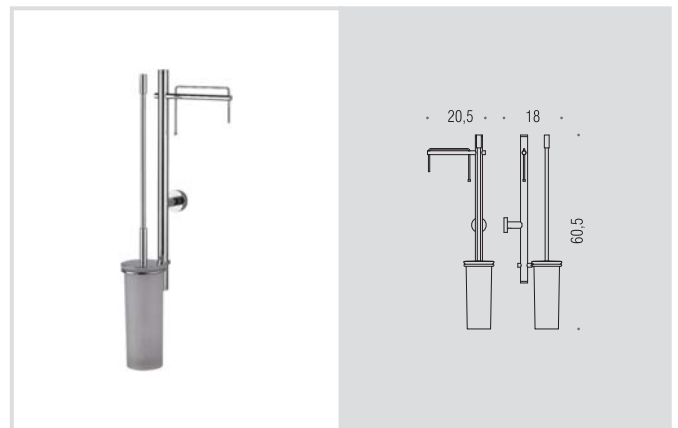
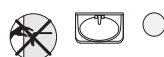

W4923
Colonna con porta rotolo e porta scopino
Column equipped with paper holder and brush holder



