



SCENE IN THE DINING-ROOM OF OSBORNE HOUSE.

Matthew 21



*Mangiadori e  
battiporta  
Pulls and door knockers*

Matteola.IT

# Barocco

## maniglioni pulls

*materiale: ottone  
material: brass*

### ***KBA16***

Ottone naturale non verniciato  
Natural brass not lacquered

Bronzo non verniciato  
Bronze not lacquered

Argento naturale non verniciato  
Natural silver not lacquered

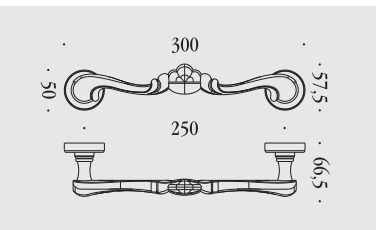

Argento naturale non verniciato  
Natural silver not lacquered



Matteood.it

# Busiri

*maniglioni  
pulls*

*materiale: ottone  
material: brass*



## **KBU16**

Ottone naturale non verniciato  
Natural brass not lacquered

Bronzo non verniciato  
Bronze not lacquered

Argento naturale non verniciato  
Natural silver not lacquered

Cromo  
Chrome

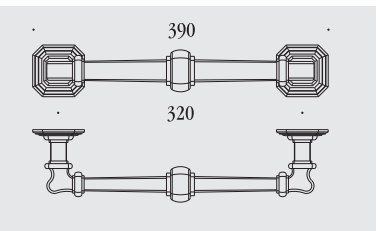

Ottone naturale non verniciato  
Natural brass not lacquered

Matteoda.it

# Busiri

## maniglioni pulls

materiale: ottone  
material: brass

### KBU26 NP

Ottone naturale non verniciato  
Natural brass not lacquered  
Bronzo non verniciato  
Bronze not lacquered  
Argento naturale non verniciato  
Natural silver not lacquered  
Cromo  
Chrome

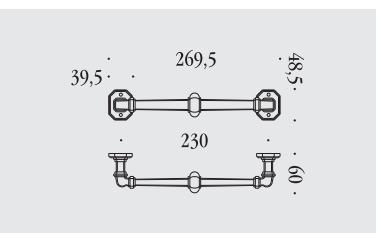

Ottone naturale non verniciato  
Natural brass not lacquered

### KBU26 PS

Ottone naturale non verniciato  
Natural brass not lacquered  
Bronzo non verniciato  
Bronze not lacquered  
Argento naturale non verniciato  
Natural silver not lacquered  
Cromo  
Chrome

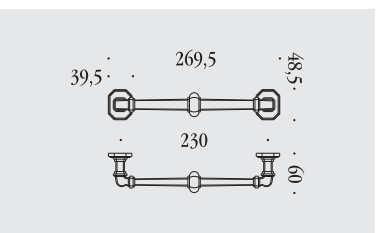

Bronzo non verniciato  
Bronze not lacquered

# Byblos

*maniglioni  
pulls*

*materiale: ottone  
material: brass*



## **KBY16**

Ottone lucido verniciato  
Lacquered polished brass  
Bronzo satinato verniciato  
Lacquered satin bronze

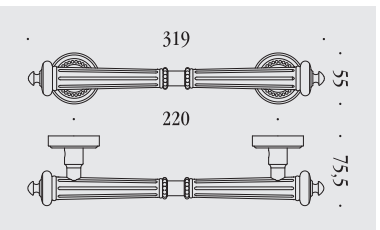

Bronzo satinato verniciato  
Lacquered satin bronze

## **KBY16 NP**

Ottone lucido verniciato  
Lacquered polished brass  
Bronzo satinato verniciato  
Lacquered satin bronze

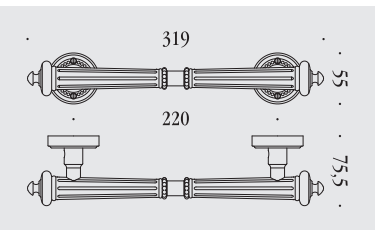

# Byblos

## maniglioni pulls

materiale: ottone  
material: brass

### **KBY26**

Ottone lucido verniciato  
Laacquered polished brass  
Bronzo satinato verniciato  
Laacquered satin bronze

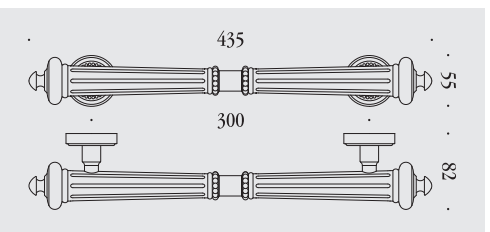

Ottone lucido verniciato  
Laacquered polished brass

### **KBY26 NP**

Ottone lucido verniciato  
Laacquered polished brass  
Bronzo satinato verniciato  
Laacquered satin bronze

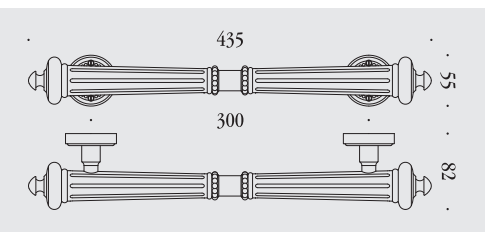

Matteodotti

**Cabri**

*maniglioni  
pulls*

*materiale: ottone  
material: brass*



**KCR16**

Ottone naturale non verniciato  
Natural brass not lacquered  
**Bronzo non verniciato**  
Bronze not lacquered

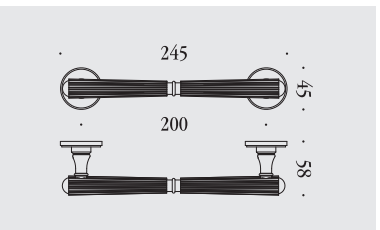

Ottone naturale non verniciato  
Natural brass not lacquered

**KCR26**

Ottone naturale non verniciato  
Natural brass not lacquered  
**Bronzo non verniciato**  
Bronze not lacquered

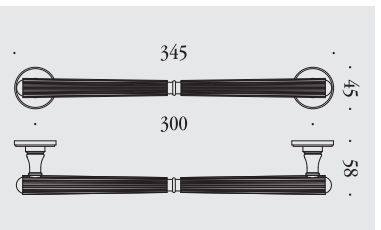

Bronzo non verniciato  
Bronze not lacquered



# Impero

maniglioni  
pulls

materiale: ottone  
material: brass

## KIM16

Ottone naturale non verniciato  
Natural brass not lacquered

Bronzo non verniciato  
Bronze not lacquered

Argento naturale non verniciato  
Natural silver not lacquered

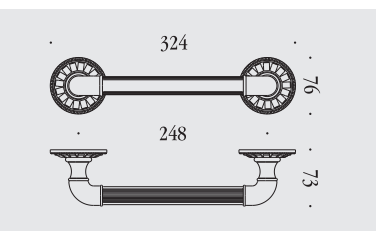

Ottone naturale non verniciato  
Natural brass not lacquered



# Impero

*maniglioni  
pulls*

*materiale: ottone  
material: brass*



## **KIM26**

Ottone naturale non verniciato  
Natural brass not lacquered  
**Bronzo non verniciato**  
Bronze not lacquered  
**Argento naturale non verniciato**  
Natural silver not lacquered

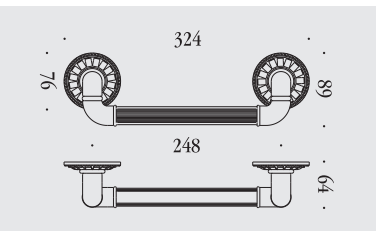

Ottone naturale non verniciato  
Natural brass not lacquered

Matteoda.it

# Louis XVI

## maniglioni pulls

materiale: ottone  
material: brass



Ottone naturale non verniciato  
Natural brass not lacquered

### **KLU16 NP**

Ottone naturale non verniciato  
Natural brass not lacquered  
Bronzo non verniciato  
Bronze not lacquered  
Argento naturale non verniciato  
Natural silver not lacquered

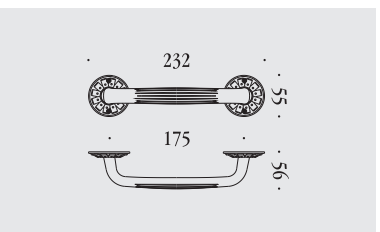

### **KLU16 PS**

Ottone naturale non verniciato  
Natural brass not lacquered  
Bronzo non verniciato  
Bronze not lacquered  
Argento naturale non verniciato  
Natural silver not lacquered

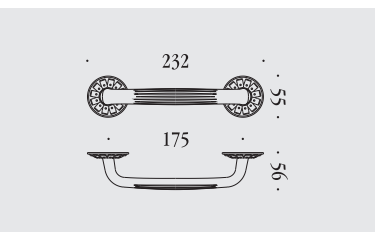



# Louis XVI

*maniglioni  
pulls*

*materiale: ottone  
material: brass*



Ottone naturale non verniciato  
Natural brass not lacquered

## **KU26 NP**

Ottone naturale non verniciato  
Natural brass not lacquered

Bronzo non verniciato  
Bronze not lacquered

Argento naturale non verniciato  
Natural silver not lacquered

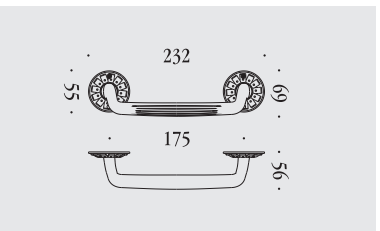

Matteoda.it

## **KU26 PS**

Ottone naturale non verniciato  
Natural brass not lacquered

Bronzo non verniciato  
Bronze not lacquered

Argento naturale non verniciato  
Natural silver not lacquered

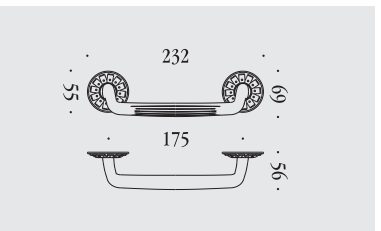

# Ottocento

## maniglioni pulls

materiale: ottone  
material: brass

### KOT16

Ottone naturale non verniciato  
Natural brass not lacquered  
Bronzo non verniciato  
Bronze not lacquered  
Argento naturale non verniciato  
Natural silver not lacquered  
Nichel naturale non verniciato  
Natural nickel not lacquered

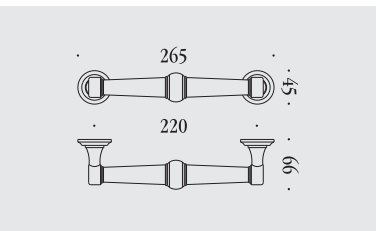

Ottone naturale non verniciato  
Natural brass not lacquered

### KOT26

Ottone naturale non verniciato  
Natural brass not lacquered  
Bronzo non verniciato  
Bronze not lacquered  
Argento naturale non verniciato  
Natural silver not lacquered  
Nichel naturale non verniciato  
Natural nickel not lacquered

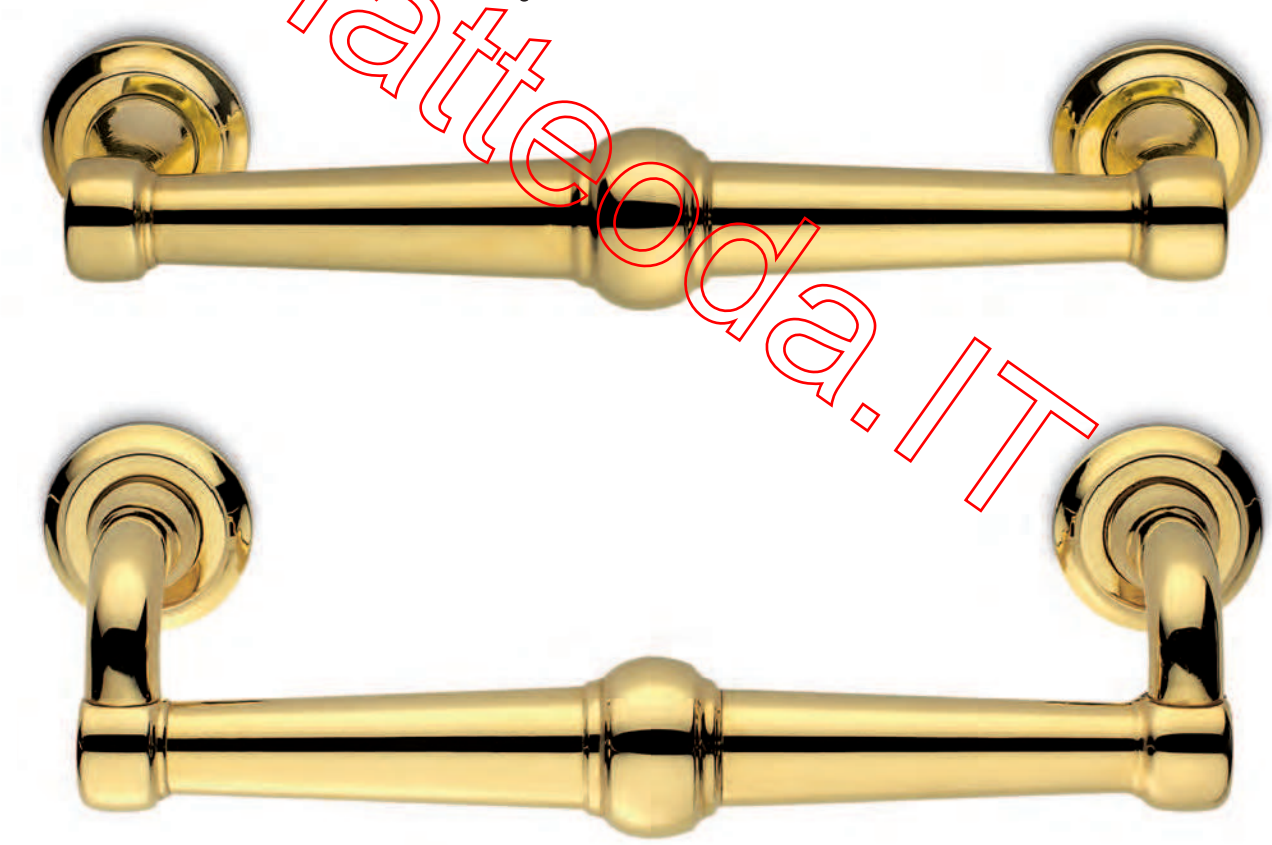
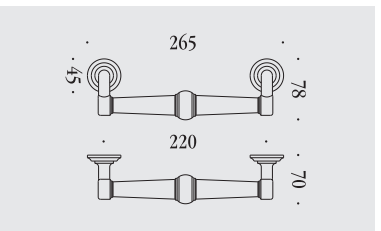

Ottone naturale non verniciato  
Natural brass not lacquered

# Venezia

*maniglioni  
pulls*

*materiale: ottone  
material: brass*

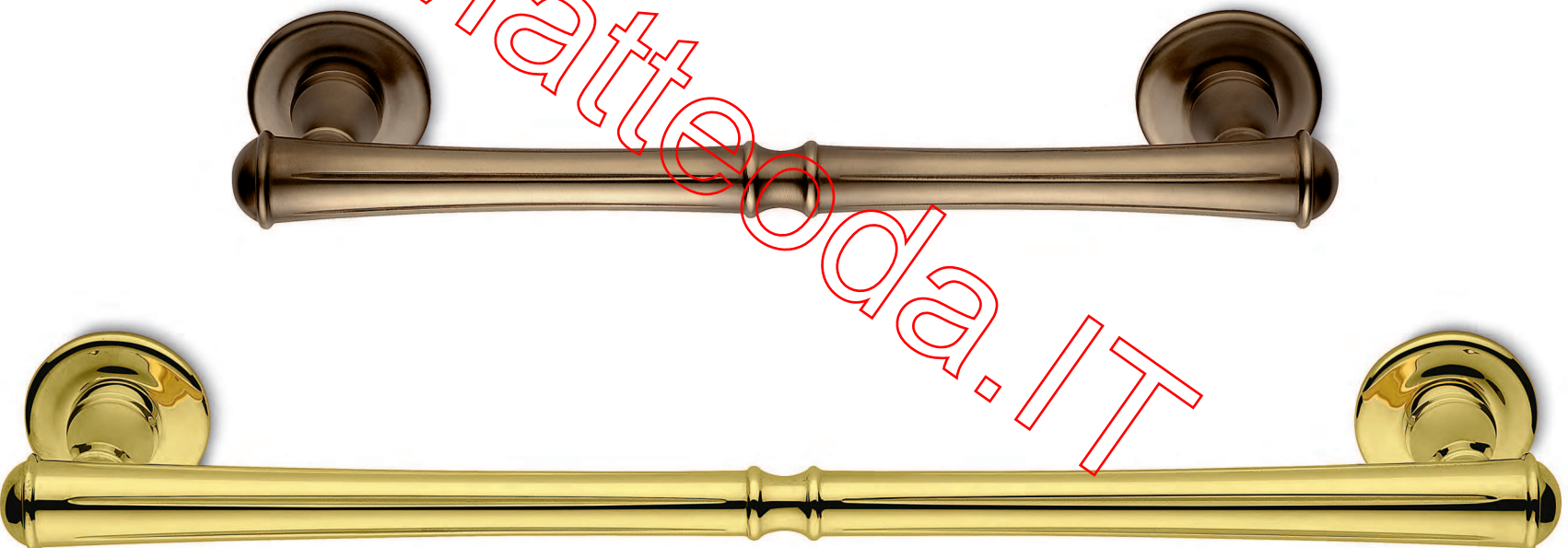

## **KVE16**

Ottone naturale non verniciato  
Natural brass not lacquered  
**Bronzo non verniciato**  
Bronze not lacquered

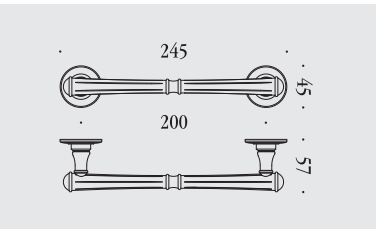

**Bronzo non verniciato**  
Bronze not lacquered

## **KVE26**

Ottone naturale non verniciato  
Natural brass not lacquered  
**Bronzo non verniciato**  
Bronze not lacquered

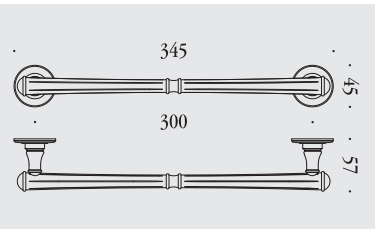

**Ottone naturale non verniciato**  
Natural brass not lacquered



# Vitto

*maniglioni  
pulls*

*materiale: ottone  
material: brass*

**K0136**

Ottone naturale non verniciato  
Natural brass not lacquered  
Bronzo non verniciato  
Bronze not lacquered

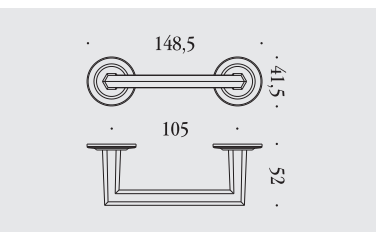

Bronzo non verniciato  
Bronze not lacquered

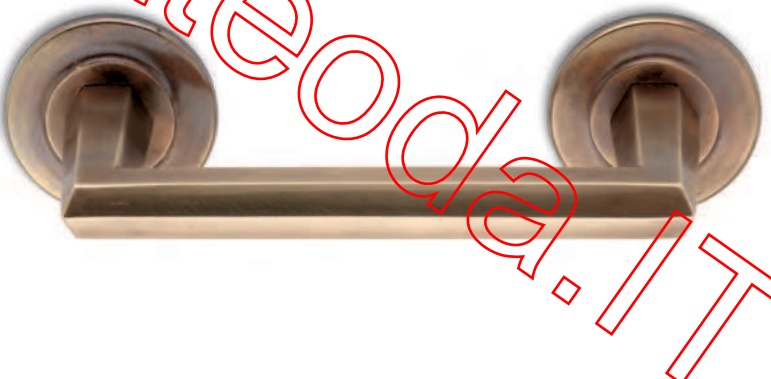

Matteodora.IT

# BUSIRI

*maniglioni per alzante scorevole  
pull-up handles for sliding door*

*materiale: ottone  
material: brass*

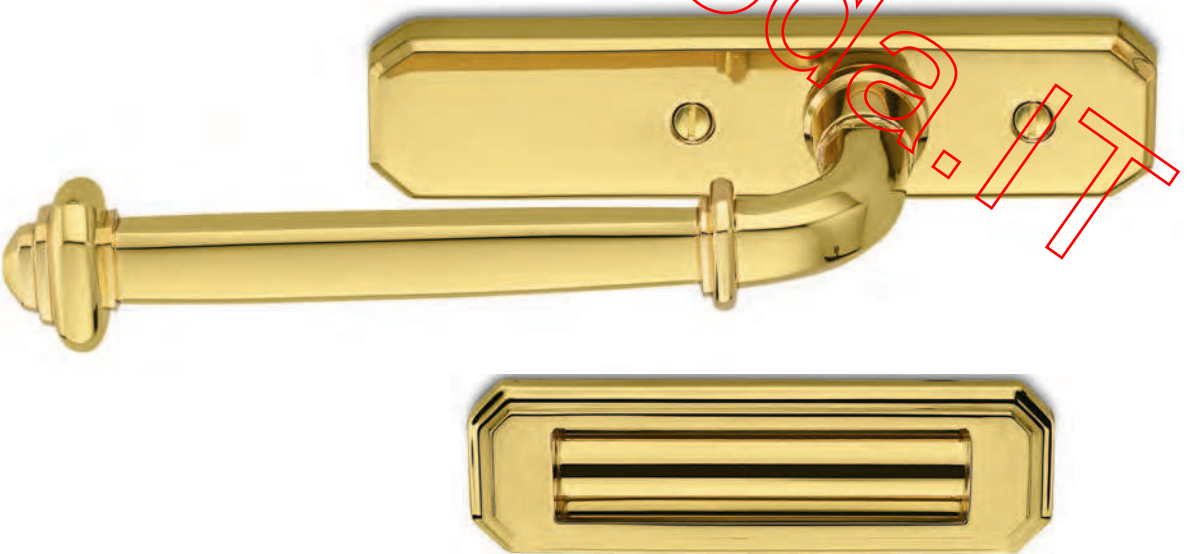

## **KB113**

Ottone naturale non verniciato  
Natural brass not lacquered

Bronzo non verniciato  
Bronze not lacquered

Argento naturale non verniciato  
Natural silver not lacquered

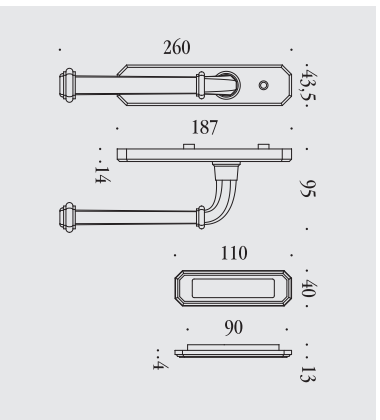

Ottone naturale non verniciato  
Natural brass not lacquered

Matteobest